



8ème Balade des Blouses Blanches du H.M.R.C

1

Dimanche 2 avril 2006

<p>4</p> <p>Hôtel de Ville</p> <p>300 1200</p>	<p>8</p> <p>Miroir Stop</p> <p>900 5600</p>	<p>12</p> <p>Rue de la Paix</p> <p>2100 10000</p>
<p>3</p> <p>Rue Jardon</p> <p>500 900</p>	<p>7</p> <p>Grand-Rechain</p> <p>1100 4700</p>	<p>11</p> <p>Route des Sources</p> <p>1300 7900</p>
<p>2</p> <p>Rue du Stade</p> <p>400 400</p>	<p>6</p> <p>Grand-Rechain Stop</p> <p>1200 3600</p>	<p>10</p> <p>SOIRON Boulangerie</p> <p>600 6600</p>
<p>1</p> <p>The Paradise PARKING</p> <p>1200 2400</p>	<p>5</p> <p>BRUYERES</p> <p>1200 2400</p>	<p>9</p> <p>XHENDELESSE</p> <p>400 6000</p>



Dimanche 2 avril 2006

16

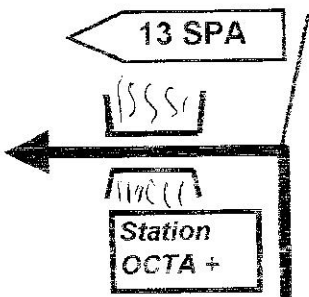

400

12150

20

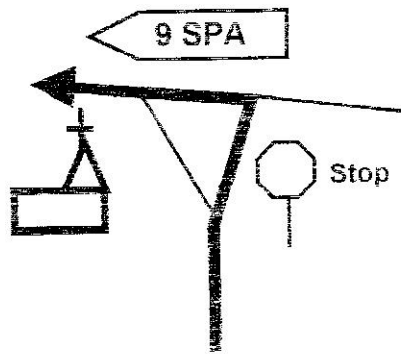

200

17150

24

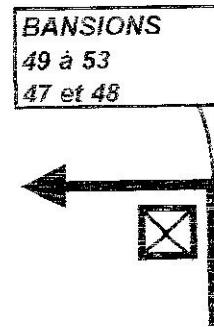

300

25650

15

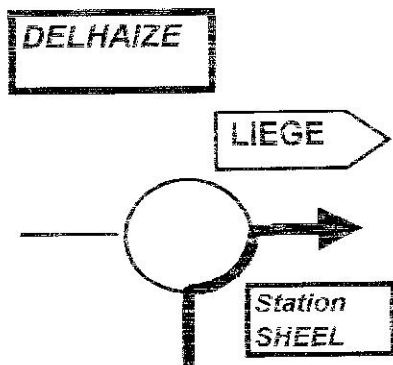

500

11750

19

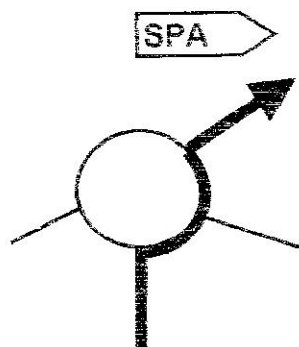

300

16950

23

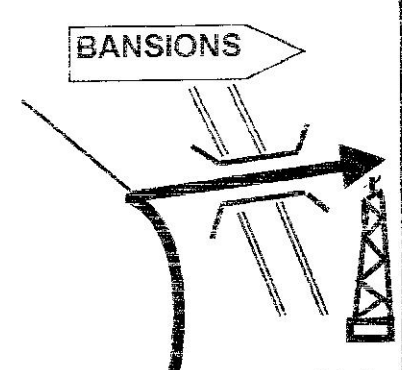

2000

25350

14

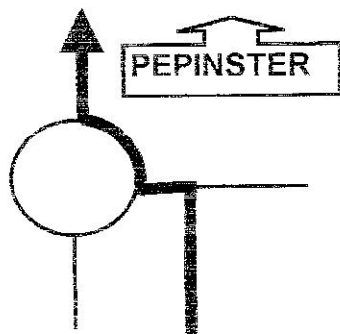

850

11250

18

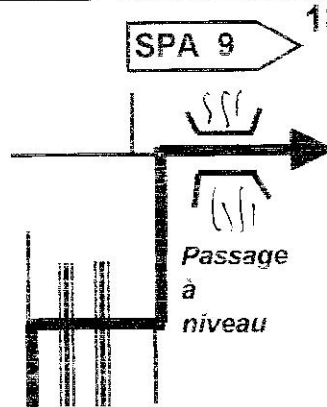

3600

16650

22

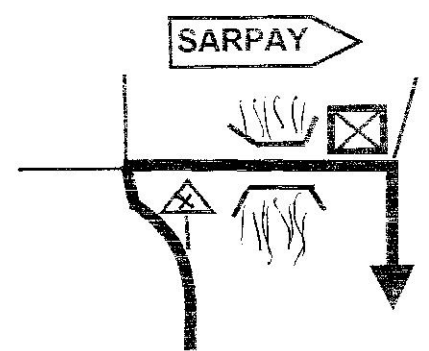

5000

23350

13

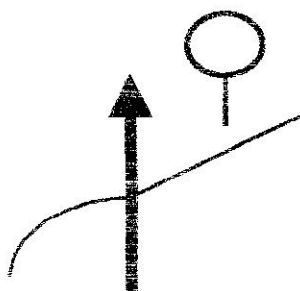

400

10400

17

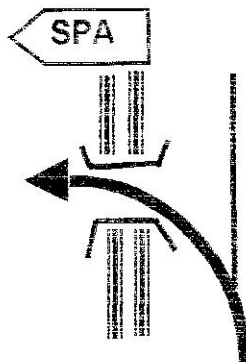

900

13050

21

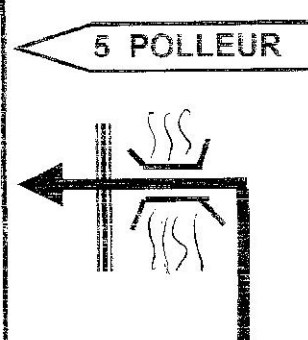

1200

18350

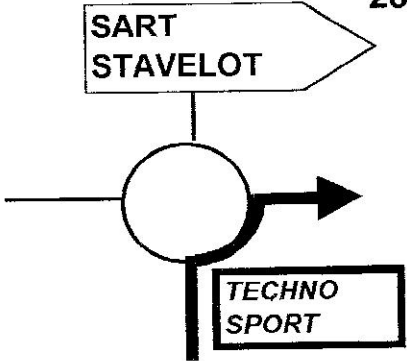
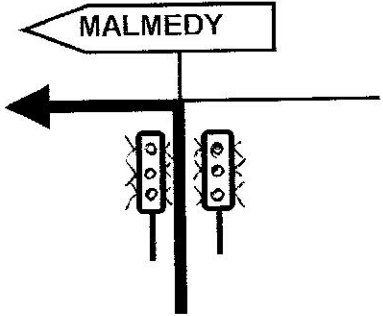
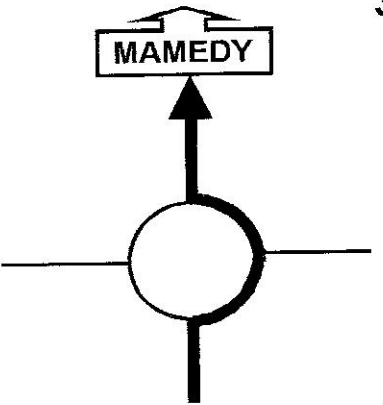
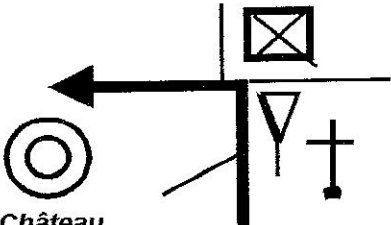
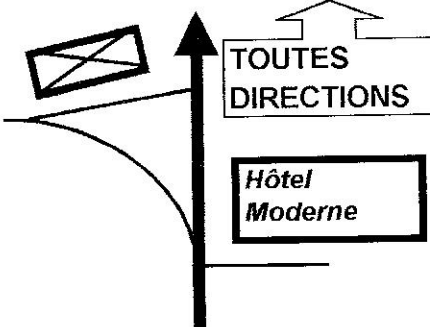
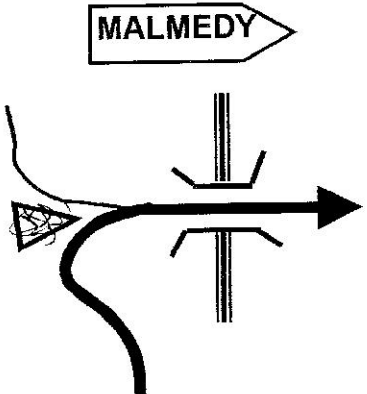
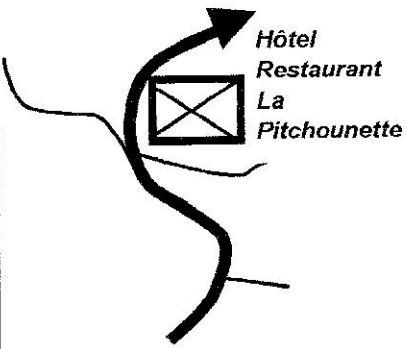
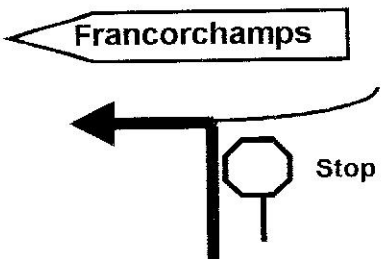
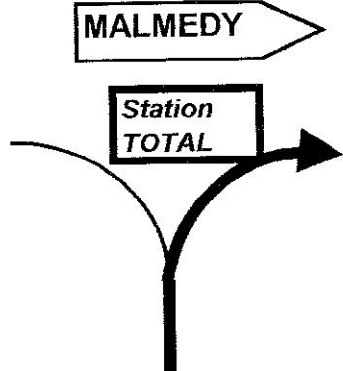
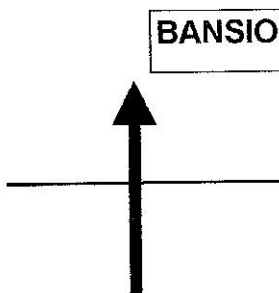
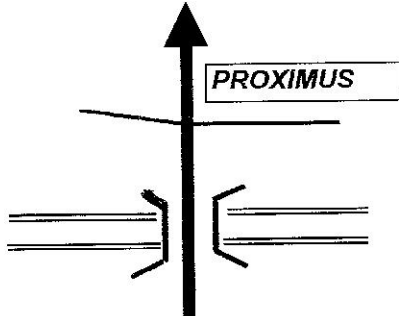
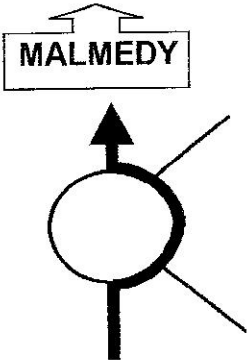

<p>28</p>  <p>200 28100</p>	<p>32</p>  <p>7300 45100</p>	<p>36</p>  <p>200 50000</p>
<p>27</p>  <p>400 27900</p>	<p>31</p>  <p>900 37800</p>	<p>35</p>  <p>3300 49800</p>
<p>26</p>  <p>1600 27500</p>	<p>30</p>  <p>1600 36900</p>	<p>34</p>  <p>1200 46500</p>
<p>25</p>  <p>250 25900</p>	<p>29</p>  <p>7200 35300</p>	<p>33</p>  <p>200 45300</p>



Dimanche 2 avril 2006

<p>40</p> <p>100 150</p>	<p>44</p> <p>3500 8650</p>	<p>48</p> <p>5500 23350</p>
<p>39</p> <p>50 50</p>	<p>43</p> <p>4800 5150</p>	<p>47</p> <p>4000 17850</p>
<p>38</p> <div data-bbox="111 1288 534 1400" style="border: 1px solid black; padding: 5px;"> <p>Remise des compteurs à zéro</p> </div> <div data-bbox="111 1456 534 1624" style="border: 1px solid black; padding: 5px;"> <p>BOWLING de Malmédy Avenue des Alliés, 100 4960 MALMEDY Tél. 080/77 08 13</p> </div>	<p>42</p> <div data-bbox="582 1276 1013 1579" style="border: 1px solid black; padding: 10px; text-align: center;"> <p>R.S.P. par FALIZE BELLEVAUX sur 4,8 km.</p> </div>	<p>46</p> <p>5100 13850</p>
<p>37</p> <div data-bbox="119 1668 319 1780" style="border: 1px solid black; padding: 5px;"> <p>BOWLING 362</p> </div> <p>1900 51900</p>	<p>41</p> <p>200 350</p>	<p>45</p> <p>100 8750</p>



Dimanche 2 avril 2006

52

3 BRAUNLAUF

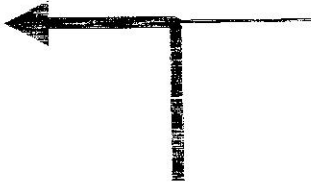

2600

27450

56

Remise des compteurs à zéro

60

BACKEREL
LENTZEN

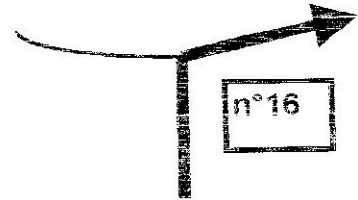

4500

6400

51

6 BRAUNLAUF



200

24850

55

Repas de Midi
Café
GENNEN Ch.
Maldingen, 2
080/22 89 53

59

R.S.P.
vers
ESPELER

50

VIELSAM 15

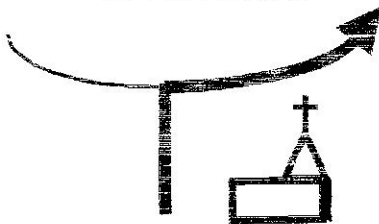

800

24650

54

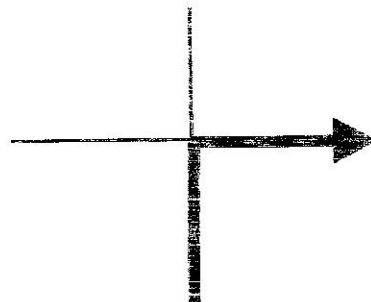

3900

32150

58

ALDRINGEN 1

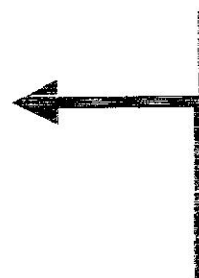

1500

1900

49

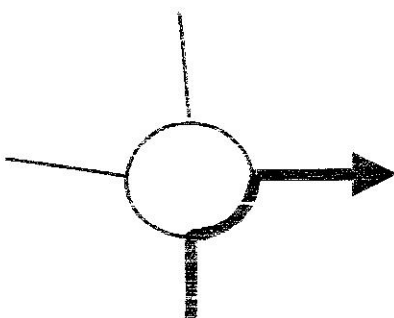

500

23850

53

BRAUNLAUF



800

28250

57

CAFE

400

400



64

R.S.P.
St. VITH
sur 17,3 km.

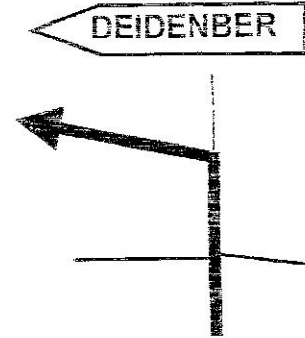

4200

36800

68

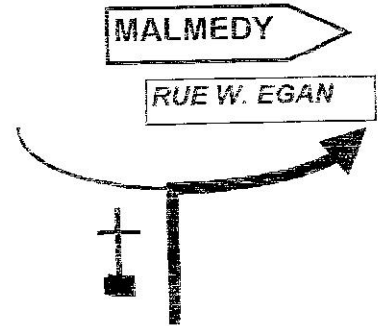

7000

49300

72

63

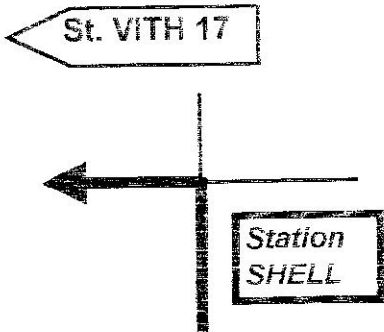

4300

14200

67

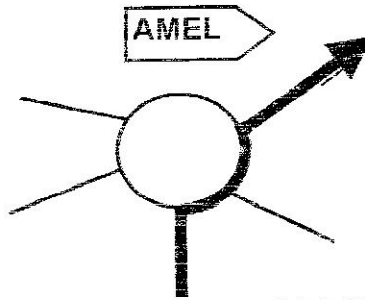

700

32600

71

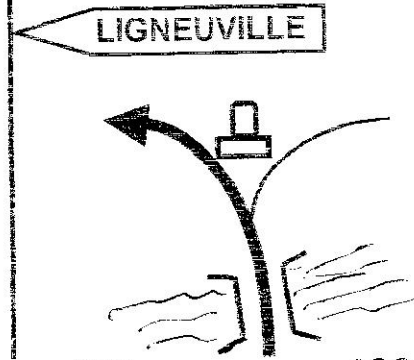

400

42300

62

R.S.P.
St. VITH
sur 4,3 km.

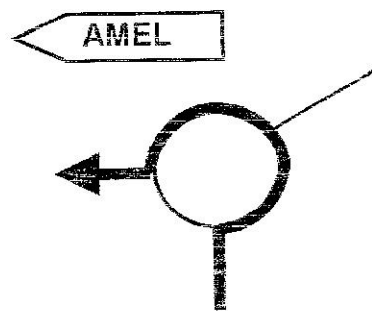

400

31900

66

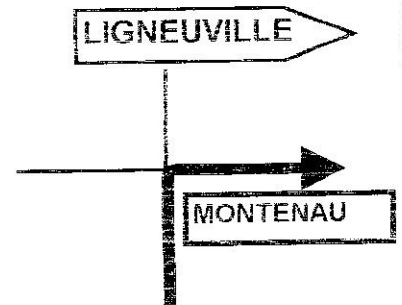

1500

41900

70

61

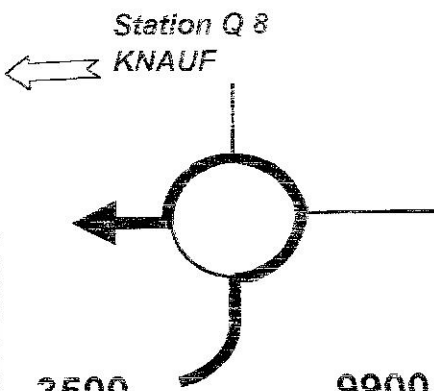

3500

9900

65

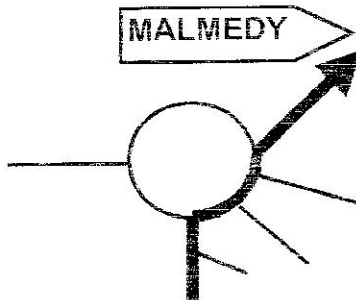

17300

31500

69

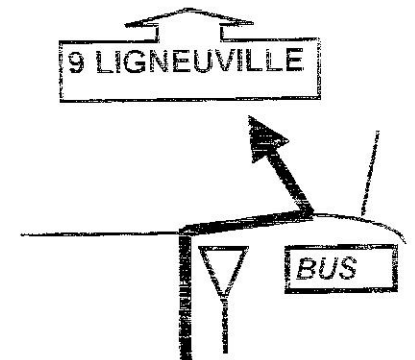

3600

40400



Dimanche 2 avril 2006

76

R.S.P.
 Vers ROBERTVILLE
 via: CHODES
 G' DOUMONT
 WAIMES
 WALK
 OVIFAT
 sur 7,5 km.

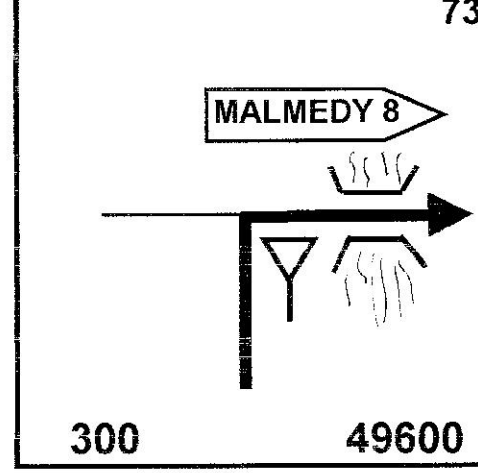
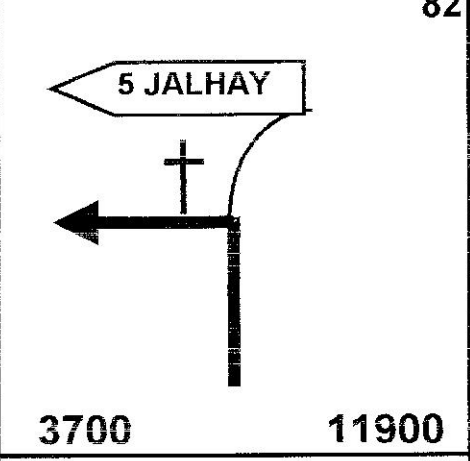
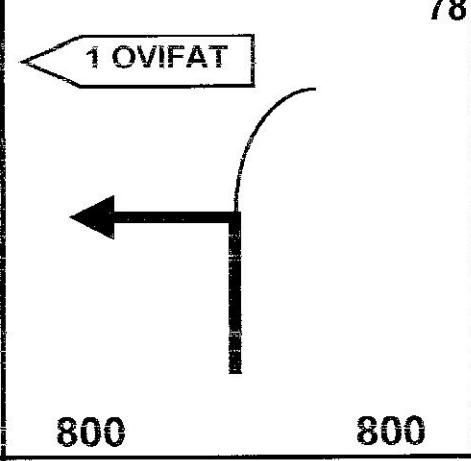
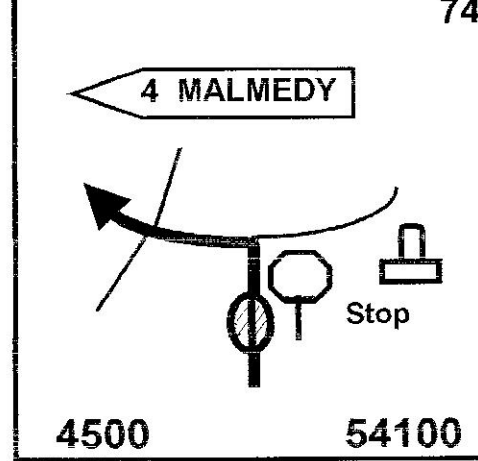
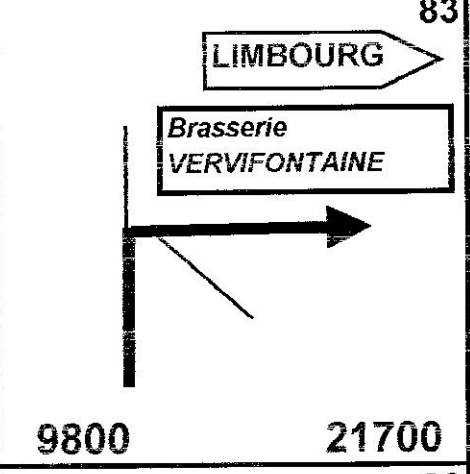
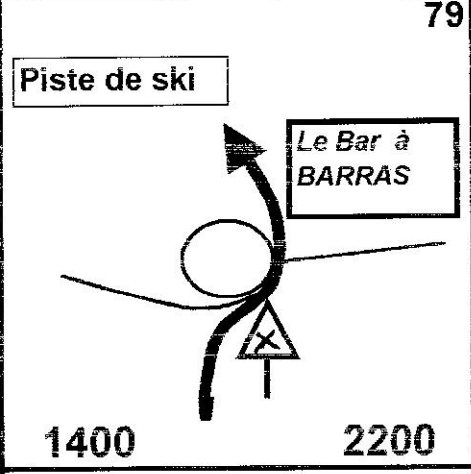
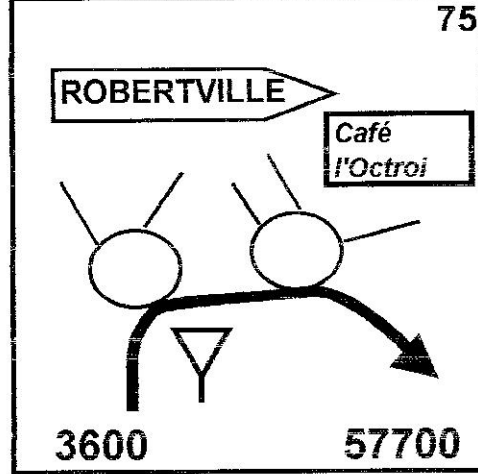
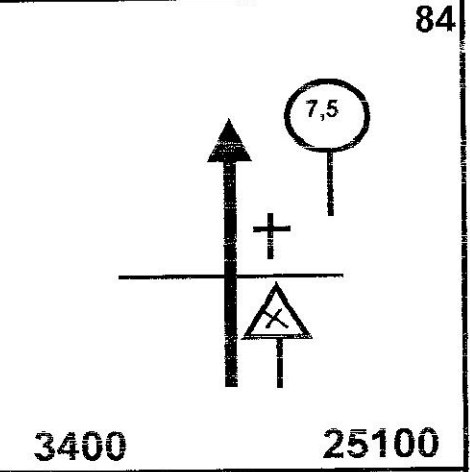
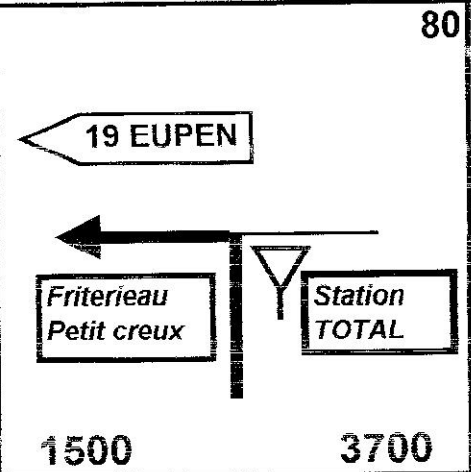

77

**Arrêt
 graissage au
 Chalet du
 BARRAGE**

Remise des
 compteurs à zéro

7500 65200

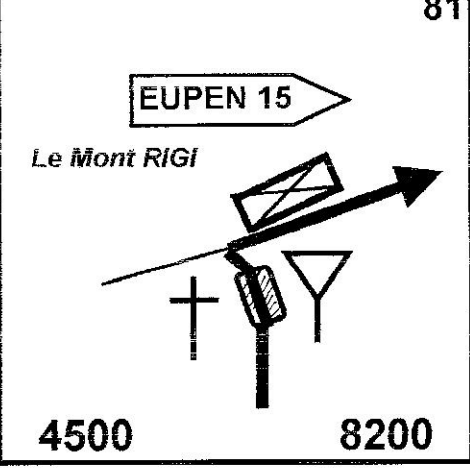

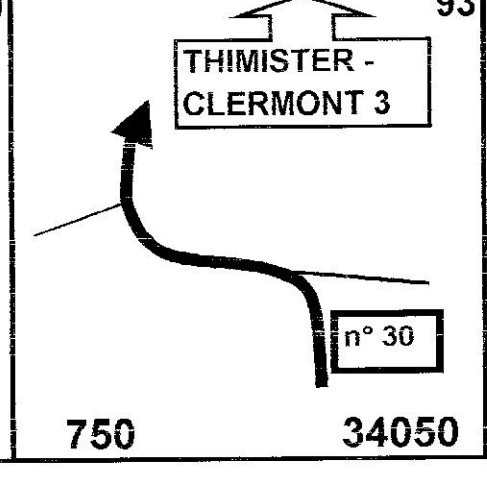
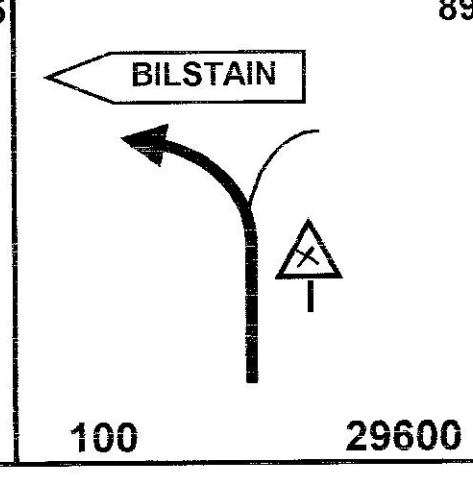
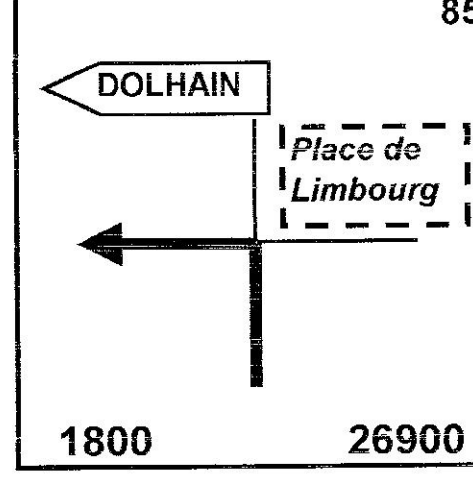
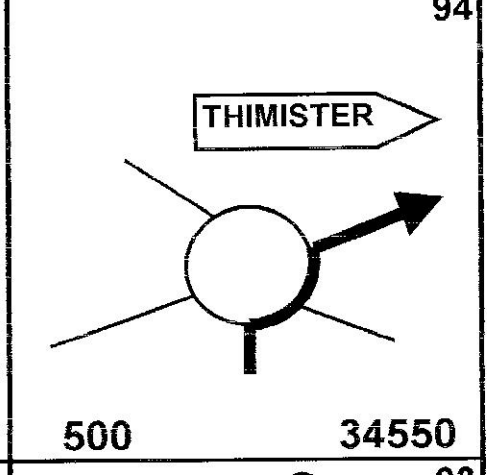
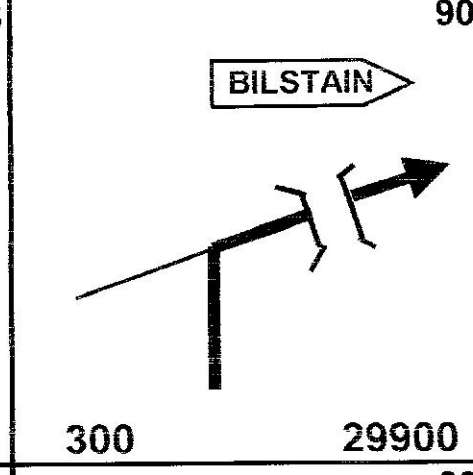
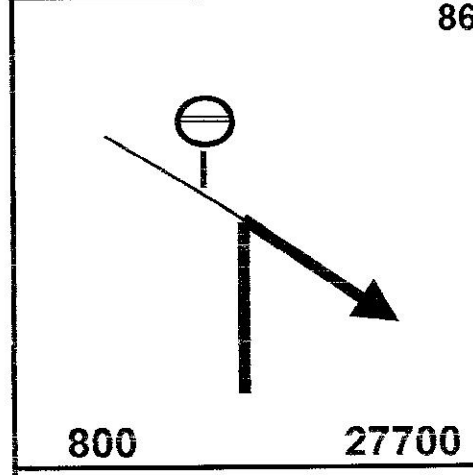
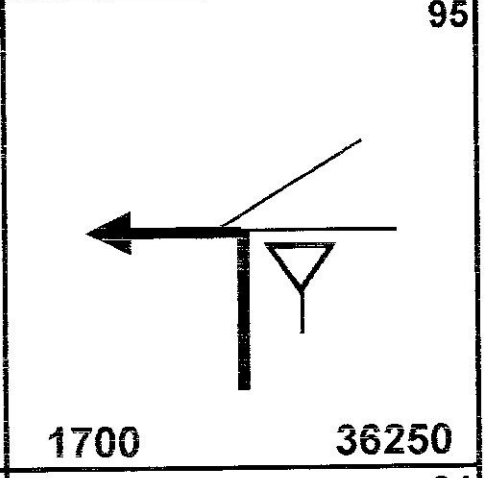
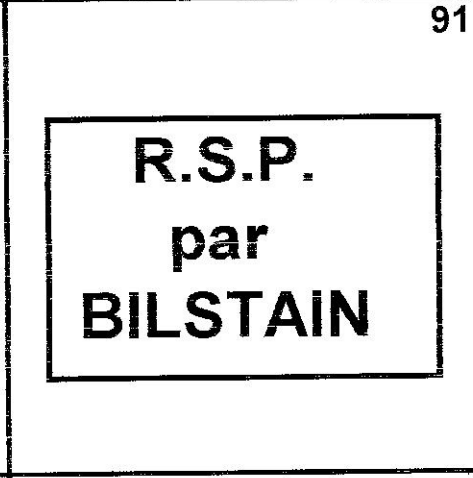
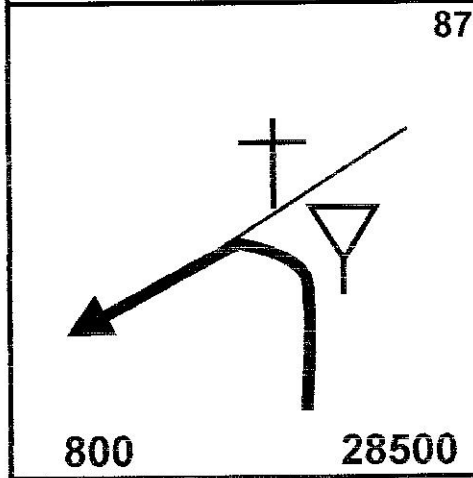
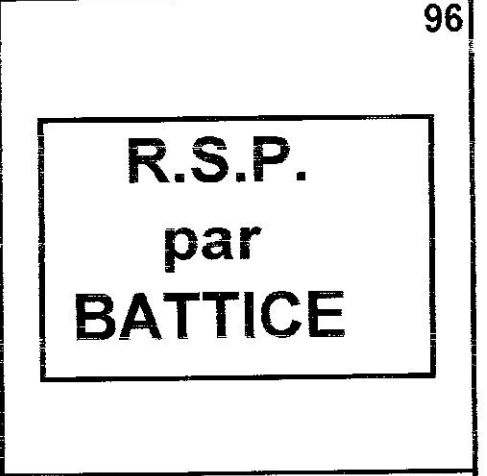
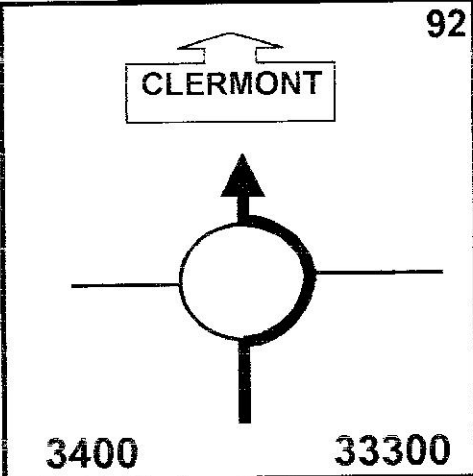
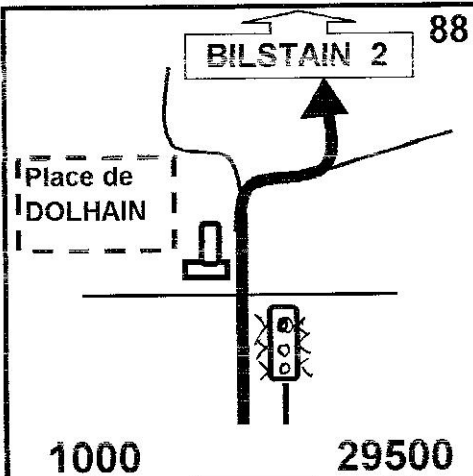



<p>100</p> <p>200 43250</p>		
<p>99</p> <p>100 43050</p>	<p>le 16 avril 2006 18 ème Balade Pascale pour motos anciennes</p>	
<p>98</p> <p>1900 42950</p>	<p>Nous espérons que vous avez passé une bonne journée,nous vous souhaitons un bon retour</p>	
<p>97</p> <p>4800 41050</p>	<p>Arrivée au parking face au café The PARADISE à HERVE</p>	